

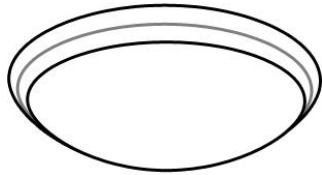

*Instructivo solo como referencia de instalación



LISTA DE PARTES:

Accesorios Anclaje

-  A-01 Pija x 3
-  A-02 Taquete x 3

PRECAUCIÓN:

1-Desconecte la fuente de energía eléctrica durante la instalación y antes de darle servicio.

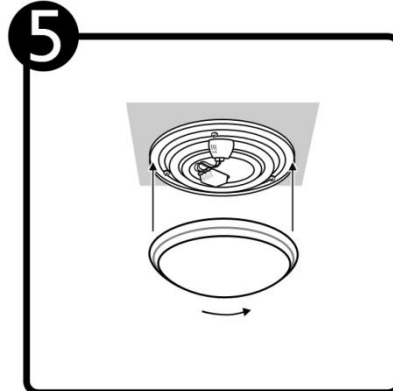
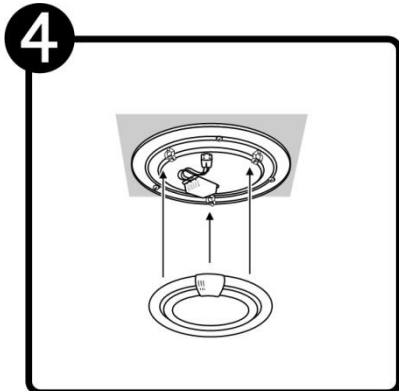
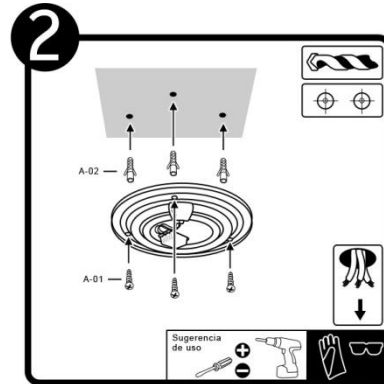
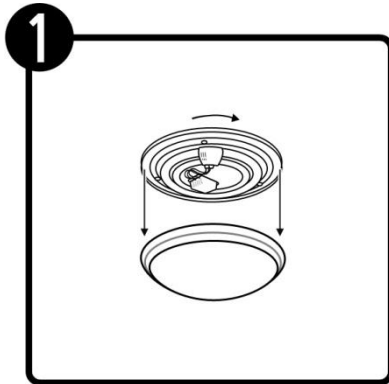

RECOMENDACIÓN: Favor de consultar el instructivo impreso que viene dentro del empaque del producto.